

REESE

You *can* take it with you.

INSTALLATION INSTRUCTIONS

Heavy Duty Round Bar Adjustable Weight Distributing Hitches

ELKHART, IN., OAKVILLE, ONT.

SMALL PARTS
PACKAGES 66014K AND 61224

DEALERS: Give these instructions to your customers.

INITIAL SET-UP

1. Line up tow vehicle and trailer on level pavement, in straight-ahead position, uncoupled.
2. Level the trailer and measure and record the distance from the ground to the top of the ball socket (dimension Fig. 1).
3. Select a hitch ball with a diameter that matches the trailer coupler size. The three most common sizes are 1-7/8", 2", and 2-5/16". Select ball with 1-1/4" or 1" threaded shank that is V-5 rated equal to or greater than trailer gross vehicle weight rating (GVWR).

WARNING: Raised balls usually have reduced load ratings. Ball rating **MUST** equal or exceed trailer GVWR.

4. Attach hitch ball to the ballmount (G). REESE standard height hitch balls with 1-1/4" shanks are supplied with lock washers and nuts (If you must use a 1" shank ball, use bushing 58109 (B) to reduce hole size in ballmount (G) to 1"). Always use a lock washer and place washer next to nut. Unless otherwise specified by ball manufacturer torque ball nut to 450 ft/lbs for 1-1/4" nut, 250 ft/lbs for 1" nut.

5. Some installations may require a longer hitch bar (D). Extended bumper guards, pickup truck "caps", or rear mounted spare tires can limit turn angles unless a longer bar is used. Individual hitch bars (D) are available in various sizes.

6. Insert the hitch bar (D) into the hitch box and install a pull pin. Place ballmount (G) onto hitch bar and move up or down for proper height. Hitch bar may be used in either the up or down position (see Fig. 2).

NOTE: Ball height should be greater than coupler height (measured in step 1) to compensate for vehicle "squat" (approximately 3/4" to 1").

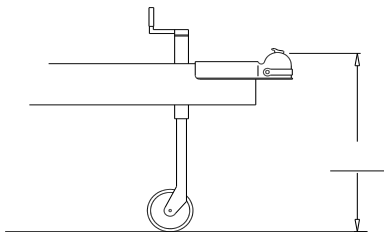
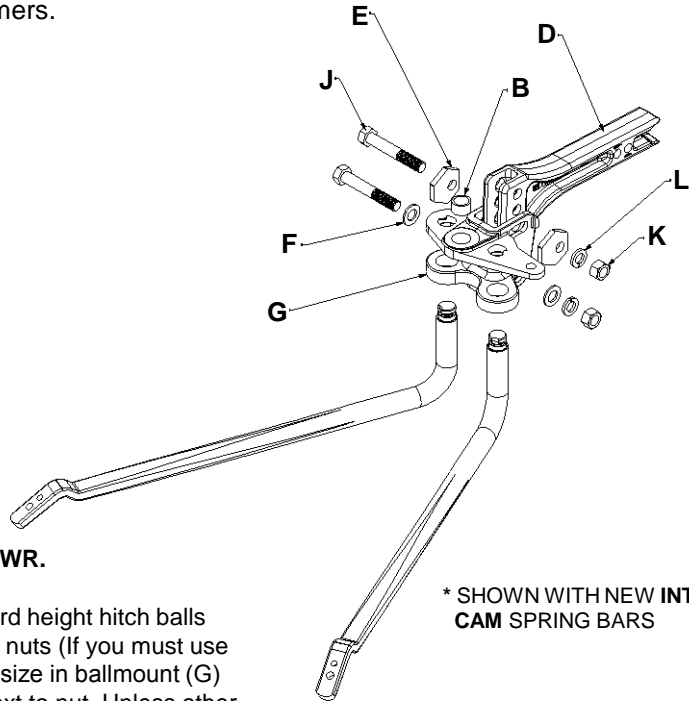

Fig. 1

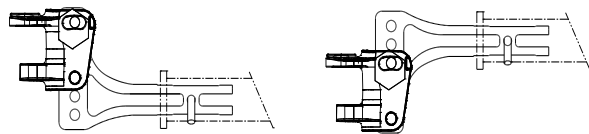

Fig. 2

For Installation Assistance or Technical Help, Call 1-800-758-0869

PRELIMINARY BALLMOUNT ADJUSTMENT

1. Insert 3/4" X 5" bolt (J) through 3/4" flat washer (F) and lower hole in ballmount and install flat washer (F), lockwasher (L), and nut (K). Rotate ballmount up until the ball is verticle or tilted slightly to the rear. Install one adjustment washer (E) on 3/4" X 5" bolt (J) and insert bolt in upper slot in ballmount. Index the washer to locate the ball mount at the proper angle. Install second adjustment washer, lock washer, and nut. Torque the 3/4" nuts (K) to 300 ft-lbs (If proper torque wrench is not available, torque nuts to 150 ft-lbs, then turn nuts an additional 1/4 turn - DO NOT lubricate the threads).

INITIAL HOOK-UP

NOTE: Car and trailer should be loaded and ready for travel before final leveling.

1. Pick reference points on front and rear wheel wells. Measure and record distance to pavement.
Front wheel well to pavement _____ Rear wheel well to pavement _____.
2. Attach chains to spring bars using U-bolts, flat washers, and locknuts. Let 2-3 threads protrude below locknut. Chain must not bind.

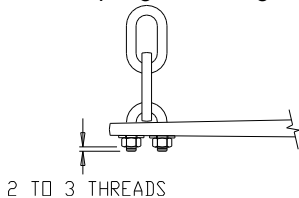

STANDARD SPRING BAR

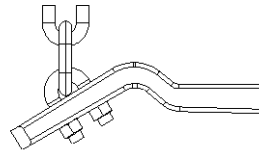

INTEGRATED CAM SPRING BAR

3. Using tongue jack, lower coupler onto ball and close coupler latch.
4. Insert formed end of spring bar into lower socket of the ballmount and push upward. Line up notch in spring bar with the tab in the upper socket, and push up until seated. Rotate the spring bar so that it is in line with the trailer frame to lock it into place (The spring bars will fit on either side, as they are not made right of left handed). Repeat procedure for the other bar.

NOTE: To release spring bar, lift up on bar and rotate so that the notch in the spring bar and the tab in the upper socket are in line, and allow bar to drop out of the ballmount.

5. Position the snap up brackets on trailer "A" frame so that the chain on the end of the spring bar is approximately vertical. Turn 1/2 X 3-1/2 bolt until it contacts frame. Then tighten 1/4 turn with wrench. **DO NOT OVERTIGHTEN.**
6. Raise trailer tongue and rear of car with jack. Lower yoke of snap up bracket until it is parallel with the ground, and slip the closest link over the hook (If there are less than 5 links between hook and u-bolt adjust ballmount angle rearward, and repeat procedure - see Fig. 3 & 4 below). With the snap up bracket handle over the yoke, raise until yoke has passed "over-center". Slide the safety pin through the small hole to lock the yoke in place. Repeat for other side.

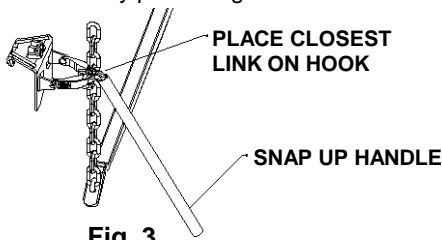

Fig. 3

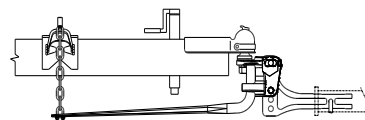

Fig. 4

7. Lower jack. Re-measure front and rear wheel well reference points (vehicle should settle evenly, within about 1/2 inch). If front has settled more than rear, increase the number of chain links between yoke hook and spring bar. If there are no more links, the angle of the head assembly must be decreased. The trailer must be uncoupled and the upper bolt removed from the head assembly. The head assembly is then pivoted up as appropriate. Reassemble. If rear has settled more than front, reduce the number of links between hook and spring bar. It is preferred that rear of vehicle settle the same or more than the front. Check to see if trailer is level, if not, you may need to re-adjust ballmount angle and / or position. Check to see that there is room for the bar and chain to move when turning a corner.

LUBRICATION

1. Place several drops of oil at spring bar / ballmount contact points. Excess oil, dirt, and grit should be wiped out whenever trailer is uncoupled.

SURGE BRAKES

Some surge brakes will not work with weight distributing hitches. CHECK TRAILER AND/OR SURGE BRAKE OPERATING INSTRUCTIONS FOR ANY SPECIAL REQUIREMENTS REGARDING WEIGHT DISTRIBUTING HITCHES. Do not use sway control with surge brakes.

Installation Instructions For Snap Up Bracket

Provides For a Stronger Attachment to the Trailer Frame.

TOOLS NEEDED:

Drill Bits: 7/16",
9/16" & 1/4"

⚠ WARNING:

Read all instructions before installing the additional bolt.
Failure to follow all of these instructions may result in death or serious injury!

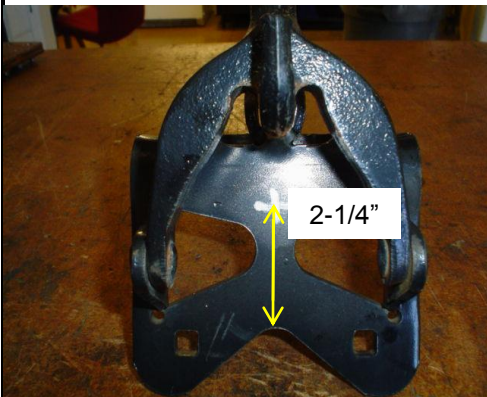

- Installation of an additional bolt into the snap up bracket.

- If your bracket does not already have a hole in this location, mark the location of the hole to be drilled into the snap up bracket. Center the hole from left to right and place it 2-1/4" above the arc in the bracket. See the picture at left.

- Before the bracket is placed on the frame, drill a 9/16" hole in the bracket



- Place the bracket in the correct place on the frame as directed in the product instructions or replace it where it was if it had already been installed.

- Using the hole in the bracket as a guide, drill a 1/4" pilot hole. Be sure to stay centered in the bracket hole.

- One method to stay centered is to use the 9/16" drill first. Just put a small dimple into the frame with the 9/16" bit. Then finish drilling with the 1/4" drill bit and then a 7/16" drill bit to get the final hole. See pilot hole to the left.



- Install the 1/2" self tapping screw into the hole in the bracket and frame. Tighten it to 50 ft/lbs.

- Re-tighten the 1/2" set screw on the inside of the frame. Turn only 1/4 to 1/2 of a turn after making contact with the frame.

PARTS LIST	
QTY	DESCRIPTION
2	1/2" x 1.00" SELF TAPPING SCREW
1	INSTRUCTION SHEET

Self Tapping
Screw is available
in service kit
58459 if needed.

For Installation or Operation Support contact CPP Technical
Service: 1-888-521-0510.

WARNINGS: LOADED BALL HEIGHT SHOULD NEVER BE GREATER THAN UNCOUPLED BALL HEIGHT. Front wheel overload and loss of rear wheel traction can result, and can lead to unstable handling, reduced braking ability, and a tendency to "jackknife" when turning and braking at the same time. IF LOADED BALL HEIGHT IS GREATER THAN UNCOUPLED HEIGHT, reduce take-up on spring bar chains and re-measure until proper height is obtained.

DO NOT CUT, WELD, OR MODIFY THE CAST BALL MOUNT.

DO NOT TOW MULTIPLE TRAILERS: Do not attempt to tow any type of trailer behind another trailer. Towing multiple trailers may cause severe instability, loss of control and/or structural failure, and may result in vehicle accident, property damage and personal injury. Towing multiple trailers is illegal in many jurisdictions.

FRONT-WHEEL-DRIVE VEHICLES: DO NOT ATTEMPT TO HOOK-UP OR TOW WITH REAR WHEELS OF TOWING VEHICLE REMOVED. Severe structural damage to towing vehicle, hitch, and trailer may result. A towing vehicle/trailer combination cannot be controlled adequately unless the towing vehicle's rear wheels are carrying their share of the load.

MAINTENANCE: Keep trunnions and sockets in head assembly free of dirt and well lubricated. Excessive wear in this area may indicate overload or inadequate lubrication. Some elongation of socket openings "seat in" is normal.

Keep head assembly exterior clean, especially the trunnion sockets. Do not allow dirt or stones to lodge between trunnions and head.

Keep hitch painted to prevent rust and maintain a good appearance. (Do not paint over labels)

AT THE BEGINNING OF EVERY TOWING DAY:

- Add drop of oil at trunnion contact areas with ball mount.
- Clean ball and coupler socket and coat ball lightly with grease.
- Check spring bar chains and U-bolts for wear. Replace before they become worn halfway through.
- Check to see that all bolts are properly tightened and hitch pin and clip are securely in place.
- Check to see that electrical hookups are in working order, and that safety chains are connected.

TOWING TIPS

DRIVING: Good habits for normal driving need extra emphasis when towing. The additional weight affects acceleration and braking, and extra time should be allowed for passing, stopping, and changing lanes. Signal well in advance of a maneuver to let other drivers know your intentions. Severe bumps and badly undulating roads can damage your towing vehicle, hitch, and trailer, and should be negotiated at a slow steady speed. IF ANY PART OF YOUR TOWING SYSTEM "BOTTOMS" OUT, OR IF YOU SUSPECT DAMAGE MAY HAVE OCCURED IN ANY OTHER WAY, PULL OVER AND MAKE A THOROUGH INSPECTION. CORRECT ANY PROBLEMS BEFORE RESUMING TRAVEL.

CHECK YOUR EQUIPMENT: Periodically check the condition of all your towing equipment and keep it in top condition.

TRAILER LOADING: Proper trailer loading is important. Heavy items should be placed close to the floor near the trailer axle. The load should be balanced side-to-side and firmly secured to prevent shifting. Tongue weight should be about 10-15 percent of the gross trailer weight for most trailers. Too low a percentage of tongue weight will often produce a tendency to sway. Excess weight on the tongue can also lead to sway and damage hitch and / or tow vehicle.

SWAY CONTROLS: A sway control can help minimize the affects of sudden maneuvers, wind gusts, and buffeting caused by other vehicles. Use of a sway control is recommended for trailers with large surface areas, such as travel trailers.

TIRE INFLATION: Unless specified otherwise by the towing vehicle or trailer manufacturer, tires should be inflated to their maximum recommended pressure.

TOWING VEHICLE AND TRAILER MANUFACTURERS' RECOMMENDATIONS: Review the owners' manuals for your towing vehicle and trailer for specific recommendations, capacities, and requirements.

POLE TONGUE TRAILERS: If your trailer has a straight tongue (instead of an A-frame tongue), it will be necessary to use a pole tongue adapter. This adapter attaches to the trailer tongue, providing a place to attach the snap up brackets.

PASSENGERS IN TRAILERS: Trailers should NOT be occupied while being towed, under any circumstances.

TRAILER LIGHTS, TURN SIGNALS, AND ELECTRIC BRAKES: Always hook up trailer lights, turn signals, electric brakes and break-away switch connection (if so equipped) even for short trips.

REMOVE HITCH WHEN NOT TOWING: Remove hitch from towing vehicle receiver when not towing, to prevent contamination of head sockets, reduce chance of striking hitch on driveway ramps or other objects, and minimize damage in the event of a rear-end collision.

LIMITED WARRANTY

Hitches - Custom Receivers - Sway Controls

Reese warrants its Hitches, Custom Hitch Receivers, and Sway Controls from date of purchase against defects in material and workmanship under normal use and service, ordinary wear and tear excepted, for the ownership life of the original consumer purchaser.

Reese will replace FREE OF CHARGE any part which proves defective in material or workmanship when presented to any Reese dealer, Reese Warehouse or return to factory. TRANSPORTATION CHARGES PREPAID, at the address below. THIS WARRANTY IS LIMITED TO DEFECTIVE PARTS REPLACEMENT ONLY. LABOR CHARGES AND/OR DAMAGE INCURRED IN INSTALLATION OR REPLACEMENT AS WELL AS INCIDENTAL AND CONSEQUENTIAL DAMAGES CONNECTED THEREWITH ARE EXCLUDED.

Some states do not allow the exclusion or limitation of incidental or consequential damages, so the above limitation or exclusion may not apply to you.

Any damage to the Hitch, Custom Hitch Receiver, and Sway Control as a result of misuse, abuse, neglect, accident, improper installation, or any use violative of instructions furnished by us, WILL VOID THE WARRANTY.

This warranty gives you specific legal rights, and you may also have other rights which vary from state to state. In the event of a problem with warranty service or performance, you may be able to go to a small claims court, or a federal district court.

Cequent Performance Products, Inc.

47912 Halyard Dr. Suite 100
Plymouth, MI 48170